

# EXPLORER NX



The perfect balance of form & function -  
Explorer NX Turn-Tilt, Balcony Windows & Doors.  
Offering superior security, noise reduction &  
weatherproofing, Explorer NX is the ideal choice when  
creating beautiful & functional living spaces.

**HBS**  
ALUMINIUM SYSTEMS



# Explorer NX Balcony



- for the Architect

## FEATURES & BENEFITS

- Balcony Turn-tilt double sash windows & doors provide world class weather performance, security and ventilation.
- The main benefit of Balcony Windows and Doors is the absence of the center mullion when fully open resulting in un-obstructed views.
- The Tilt function provides passive ventilation when the rest of the door is closed, but with a measure of weather proofing intact.
- Very low air and noise infiltration is achieved using a center seal.
- High quality ROTO NX hardware provides for long service life with 10 Year Warranty on functionality\*

## TYPICAL AREAS OF USE

- NX Balcony is used domestically, in guest houses, offices & hotels.
- Floor-to-ceiling or integrated into larger screens or facades.

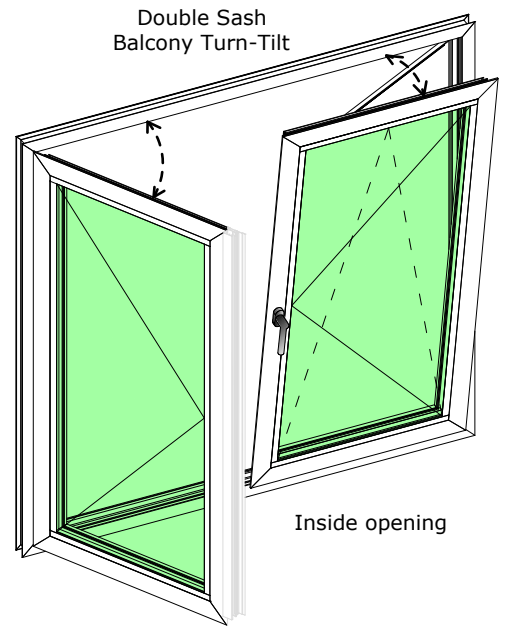

## SPECIFICATIONS

- 2500mm max Sash height.
- 130kg max. Sash weight
- 32,5mm max. Glazing thickness.
- SANAS accredited A4 2500pa test pass.
- 5 to 10 point locking for high Security.
- Variable handle height.
- Inside opening sashes allow for easy maintenance & cleaning.

## PRODUCT TYPES

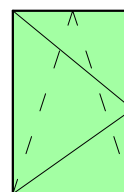

LEFT

**SINGLE SASH TURN-TILT**  
up to 1400 x 2500mm

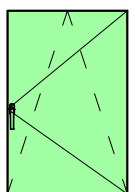

RIGHT

**DOUBLE SASH BALCONY TURN-TILT**  
up to 2100 x 2500mm

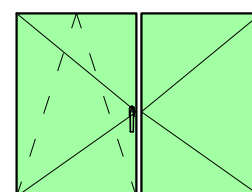

LEFT

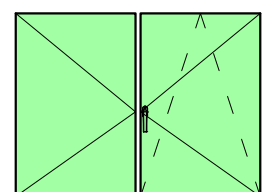

RIGHT

- Black and Silver Grey colours are available from stock.  
Other colours available on min. order qty.



\* SUBJECT TO COMPLIANCE WITH ALL ROTO FRANK & HBS GUIDELINES FOR BUILD, INSTALLATION & USAGE OF EXPLORER NX PRODUCTS.



# Explorer NX Balcony

## - for the Fabricator

Single Sash  
Turn-Tilt

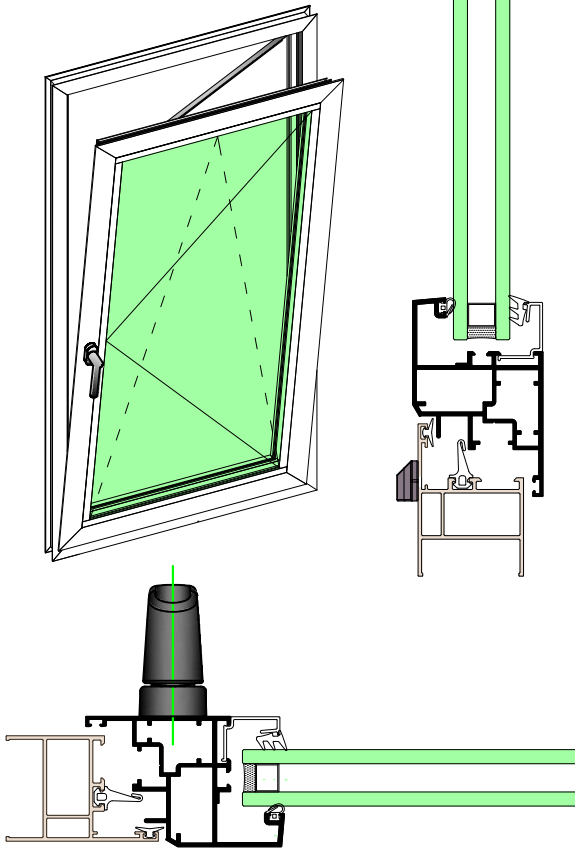

### FEATURES & BENEFITS

- NX is much easier to get right than previous Turn-tilt systems due to the adjustability and quality of ROTO hardware.
- Pneumatic punching of the NX Sash profiles allows for consistent joint assembly and overall product finish.
- Common NX hardware for both Single sash and Double sash products simplifies the learning curve.

### TESTING & PERFORMANCE

- Tested to SANS613:2011 in an accredited ISO17025 test lab.
- A4 pass from minimum size up to 1800mm height.
- A2 pass from 1801-2400mm
- A1 pass from 2401-2500mm

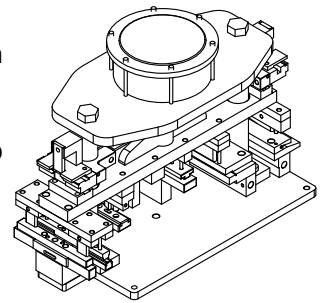

HEX170 pneumatic tool

### EXPLORER NX IN GINERI QUICK QUOTE

As the fabricator you have access to -

- Quick building and costing.
- Cutting List, Quotation & Material Order.
- Full NX hardware & accessory list is provided.
- Shop drawings in CAD format as usual.

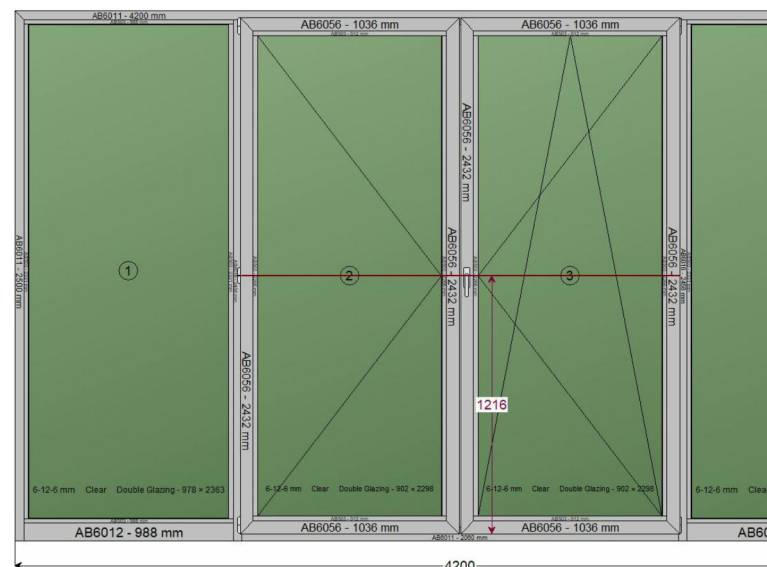

### Cutting List

Project no. : 22      Date: 2024/10/03  
 HBS Explorer - Screens, Windows and Doors      temp

		HSG12	
AE211	w	9	8
	w	18	8

Window code: 1      Site: \_\_\_\_\_  
 Item ID: 1      Apartment: \_\_\_\_\_  
 Quantity: 1      Room: \_\_\_\_\_

ID	Description	Width x Height	No of
1.4	6-12-6 mm Clear Double Glazing	978 x 2363	2
2.3	6-12-6 mm Clear Double Glazing	901,7 x 2296,2	2

Colors  
 Colour Group: Nat15  
 Colour Code: \_\_\_\_\_  
 Seal Color: Black

Image	Code	Location	Dimension	No of
42mm Frame				
	AB6011	w	2060	1
		w	4200	1
		H	2500	1
		H	2500	1
85mm Rail				
	AB6012	w	988	2
Explorer Balcony Sash				
	AB6056	w	1036	4
		H	2432	4
120mm Mullion / Transom				
	AB6016	H	2458	2
Explorer Balcony Sill				
	AB6055	H	2392	1

Accessory	Code	Description	No of
	HEX109	Sealing Pad	2
	HEX149	Mullion / Transom Connector - 18mm	2
	HEX152	Mullion / Transom Connector	8
	HEX152	Mullion / Transom Connector	2
	HEX300	ESPAÑOLETTE 860	1
	HEX301	CORNER 1 PIN	4
	HEX302	CORNER 1 PIN FOR HINGE	1
	HEX303	STAY HINGE	2
	HEX304	PIN FOR STAY HINGE	2
	HEX305	HINGE PIVOT REST	2
	HEX306	ALIGNMENT DEVICE	1
	HEX308	HINGE EXTENSION	2
	HEX309	REBATE HINGE LEFT	1
	HEX310	REBATE HINGE RIGHT	1
	HEX314	500 STAY ARM RIGHT	1
	HEX316	500 STAY GUIDE	1
	HEX318	SAMBA HANDLE-SILVER	1
	HEX325	LEVER ESPAÑOLETTE	1
	HEX326	WIND LOCK-SASH SIDE	5
	HEX327	WIND LOCK-FRAME SIDE	5
	HEX328	REBATE HINGE CORNER	1
	HEX329	REBATE STAY ARM LEFT	1

2024/10/03 11:30:28      1      Version: 5.26 HBS      gineri.com

# REASONS WHY ARCHITECTS, FABRICATORS AND HOME OWNERS LOVE NX BALCONY

## 1. EUROPEAN STYLE FENESTRATION

Choose our groundbreaking NX Balcony system for secure, high quality windows and doors. Compliance with SANS613 A4 performance class allows it to be specified and installed in almost all occurring conditions in South Africa and regionally.

## 2. ENERGY EFFICIENT & DURABLE PRODUCTS

Glazing up to 32.5mm thickness allows for low U-values which promotes energy savings. Our profiles combined with classic German engineered hardware allows for effortless and long lasting products with superior performance.

## 3. QUICKER FABRICATION & FLEXIBLE INSTALLATION

Quality assured precision punching, makes machining and fabrication efficient, faster and more cost effective.

This internally glazed system can be installed from inside or outside. Glazing and Maintenance does not require scaffolding.

## 4. LOCALLY STOCKED & SUPPORTED

All NX Balcony profiles and hardware are available off the shelf, so no extended lead times. Place the order, choose the colour and you will be fabricating and installing in no time.

## 5. HIGH SECURITY

Multi-point locking with up to 10 lock points per sash allows for extra security.



ALUMINIUM SYSTEMS

[www.hbs.co.za](http://www.hbs.co.za)